

Schraubenabstand (A»)

Produkt zu ersetzen :

Nicht identifiziertes Doppel-Schloss

Ersatzprodukt :

LR 180 * * AS-(A) (prudhomme S.a.)

Optionen

- CP/DV (Bohrkaliber)
- CP/180 (Bohrkaliber)

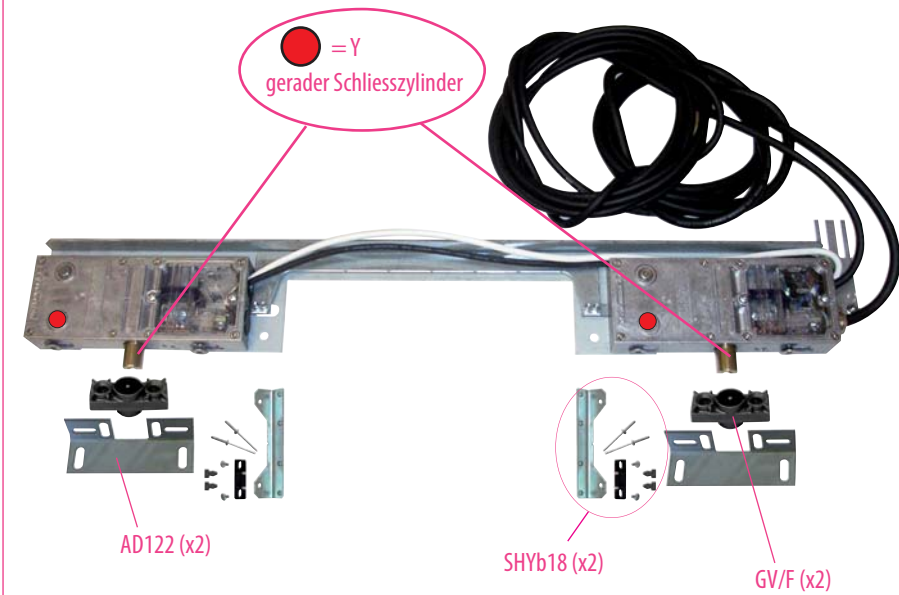

Schraubenabstand						
(A) =	600	520	460	360	320	320
B =	100	80	80	80	80	35

Schraubenabstand (A)

Schraubenabstand						
(A) =	600	520	460	360	320	320
B =	100	80	80	80	80	35

réf. : LR180 **HG** AS (A)

réf. : LR180 **HD** AS (A)

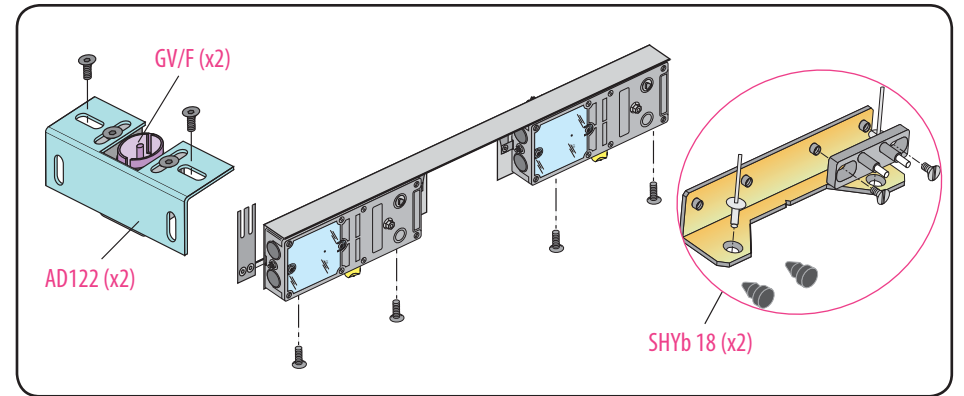
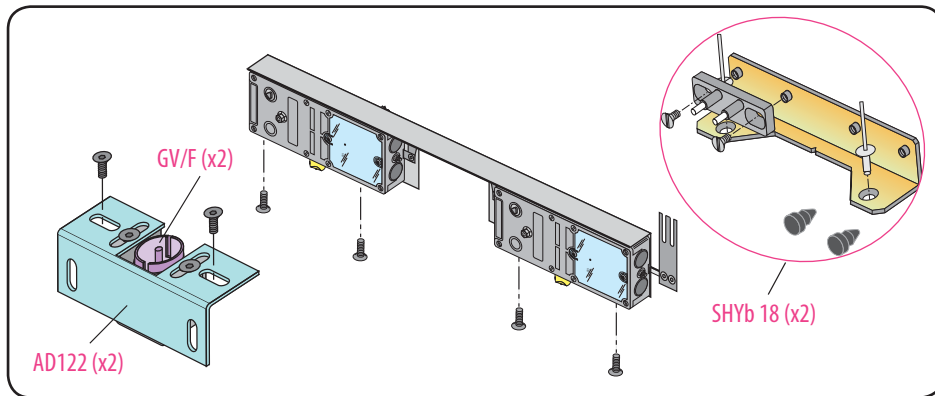
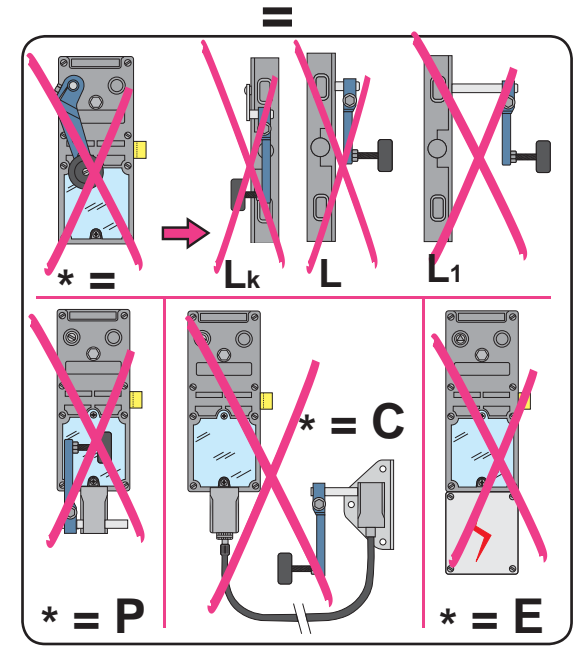
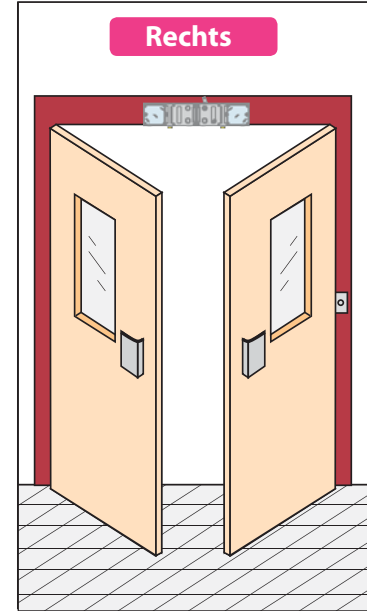
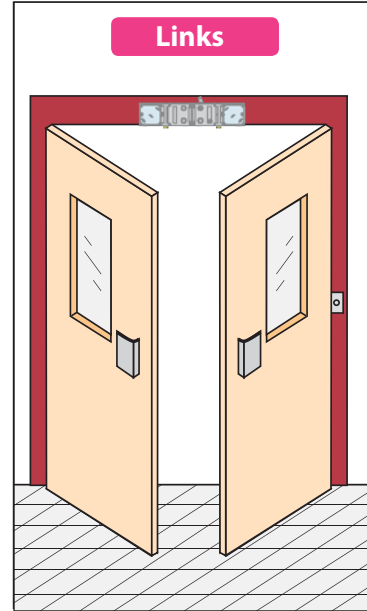
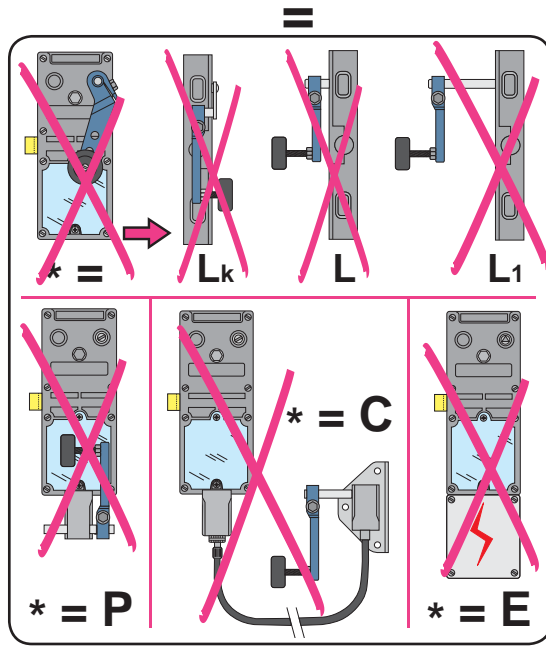

Schraubenabstand (A»)

Montage-Phasen :

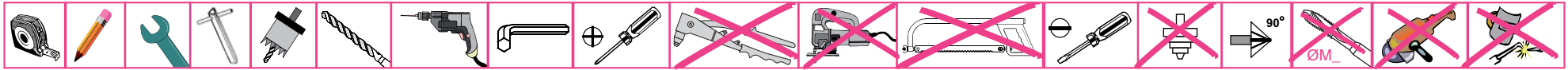

Schraubenabstand						
(A) =	600	520	460	360	320	320
B =	100	80	80	80	80	35

